

T H E E L E M E N T

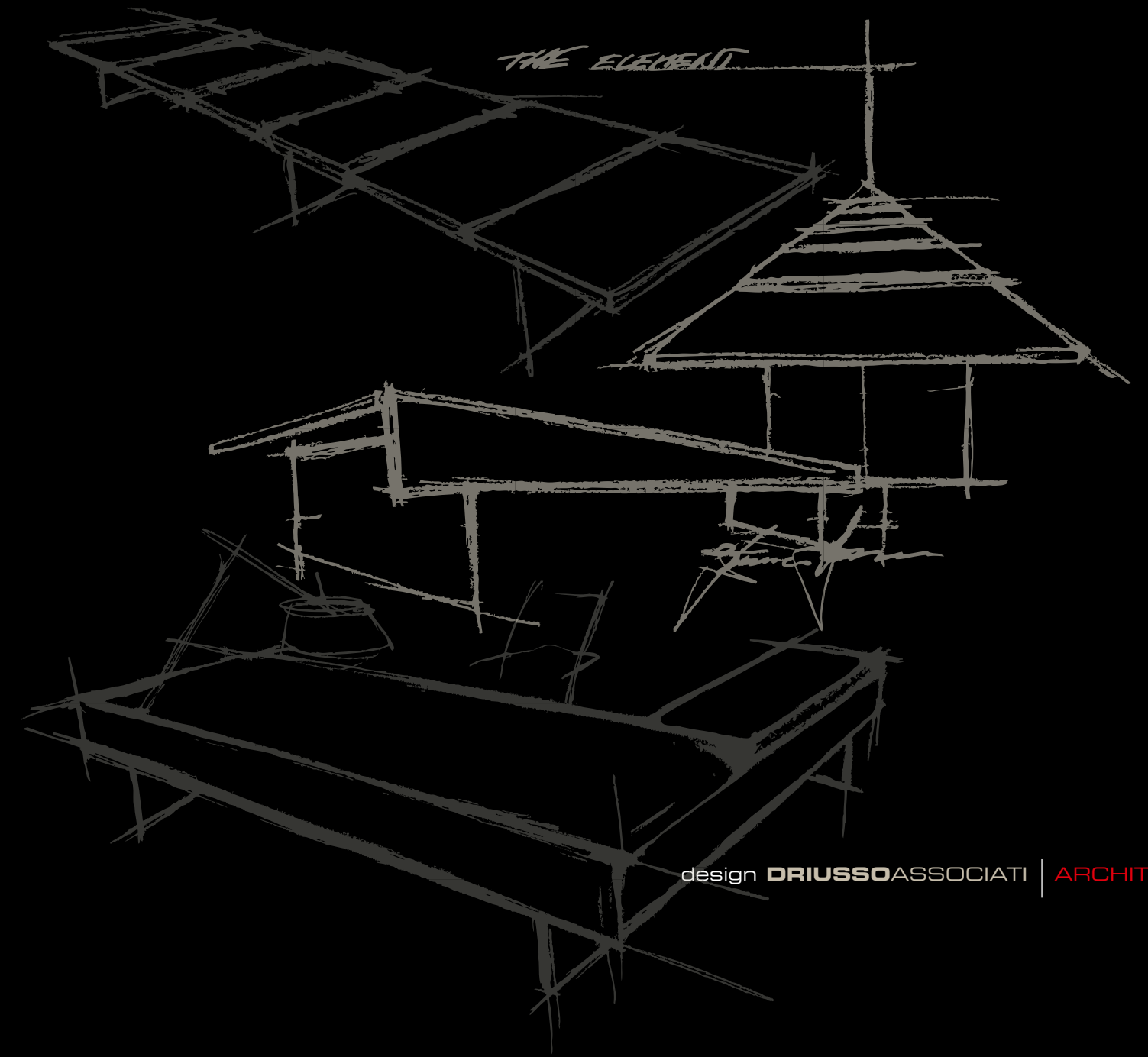

uffix[®]



THE ELEMENT

design **DRIUSSOASSOCIATI** | ARCHITECTS



Arch. Franco Driusso

NATURAL SENSING

Un nuovo equilibrio tra forma, materia e spazio. E' il concept progettuale che ha dato vita a The Element, la nuova collezione di Uffix nata da un pensiero ispirato alla purezza estetica e alla riduzione formale. Un design senza tempo, assoluto, che supera le tendenze ed esprime una sensazione di immediata armonia.

A new balance among shape, material and space. This is the planning concept that gave birth to The Element, Uffix new collection, born by a thought inspired by aesthetical pureness and formal reduction. A timeless, absolute design which overcomes the trends expressing an immediate harmonic feeling.

Un nouvel équilibre entre forme, matière et espace. C'est le concept qui a donné naissance à The Element, la nouvelle collection d'Uffix inspirée par une certaine idée de la pureté esthétique et par la réduction formelle. Un design en dehors du temps, absolu, qui dépasse les tendances en exprimant une sensation d'harmonie immédiate.

Eine neue Ausgewogenheit zwischen Form, Materie und Raum. Dies ist das neue Planungskonzept, das The Element Leben verliehen hat, die neue Kollektion von Uffix, die einem Gedanken entspringt, der durch ästhetische Reinheit und formelle Reduzierung inspiriert wurde. Ein zeitloses und absolutes Design, das die Tendenzen überwindet und ein Gefühl sofortiger Harmonie zum Ausdruck bringt.

Un nuevo equilibrio entre forma, materia y espacio. Es éste el concepto de proyecto que dió vida a The Element, la nueva colección de Uffix, nacida de un pensamiento inspirado a la pureza estética y a la reducción formal. Un diseño sin tiempo, absoluto, que supera las tendencias expresando una sensación de armonía inmediata.

Новое равновесие формы, материи и пространства. Это – концепция проектирования, из которой возникла новая коллекция The Element от Уффикса, рожденная мыслью вдохновлённой эстетической чистотой и минимализмом. Это дизайн вне времени, абсолютный, выходящий за пределы тенденций и выражающий чувство мгновенной гармонии.

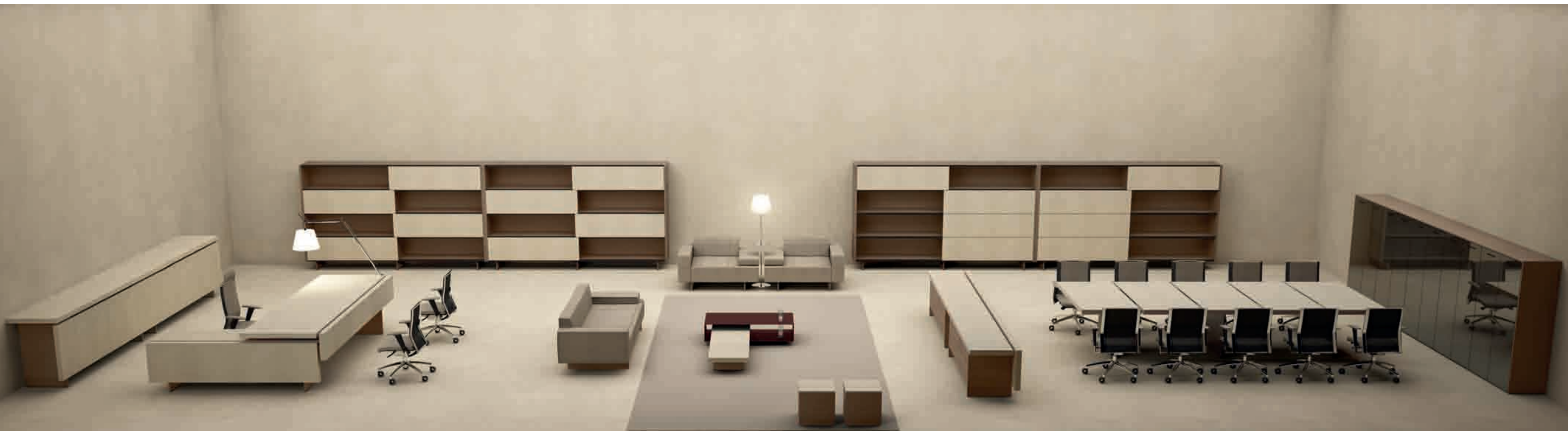

T H E E L E M E N T

TIMELESS DESIGN









Piani / Top / Fianchi scrivania / Ante: **essenza noce**
Worktops / Tops / Desk sides / Doors: **walnut veneer**
Surfaces / Partie supérieure / Flancs bureau / Portes: **essence noyer**
Platten / Abdeckplatten / Schreibtischaußenseiten / Türen: **Holzart Nussbaum**
Planos / Topes / Laterales escritorio / Puertas: **nogal**
Столешницы / верхние панели / Боковые панели письменных столов / створки: **из древесины ореха**





Piani / Top / Fianchi scrivania / Ante: **essenza wengè**
Worktops / Tops / Desk structure / Doors: **wengè veneer**
Surfaces / Partie supérieure / Flancs bureau / Portes: **essence wengè**
Platten / Abdeckplatten / Schreibtischaußenseiten / Türen: **Holzart Wengè**
Planos / Topes / Laterales escritorio / Puertas: **wengé**
Столешницы / верхние панели / Боковые панели письменных столов / створки: из древесины венге



NATURAL TOUCH





Piani / Top / Ante: **cuoio** - Fianchi scrivania: **essenza noce**
Worktops / Tops / Doors: **hide** - Desk sides: **walnut veneer**
Surfaces / Partie supérieure / Portes: **cuir** - Flancs bureau: **essence noyer**
Platten / Abdeckplatten / Türen: **Leder** - Schreibtischaußenseiten: **Holzart Nussbaum**
Planos / Topes / Puertas: **cuero** - Laterales escritorio: **nogal**
Столешницы / верхние панели / створки: **из кожи** - Боковины письменных столов: **из древесины ореха**







UNGLAZED PORCELAIN

Le molteplici finiture come il legno, il cuoio ed il gres porcellanato, si ispirano ai colori e agli elementi presenti in natura, rievocando la quotidiana interazione con il nostro habitat. I piani scrivania ed i fianchi in multistrato di alluminio, creano giochi di forme e di volumi leggeri e sospesi.

The numerous finishes as wood, hide and unglazed porcelain, take inspiration from colours and natural elements, recalling the day-to-day interaction with our habitat. The worktops and side panels in multilayer aluminium give birth to a game among shapes, lights and suspended volumes.

Les finitions multiples comme le bois, le cuir et le grès cérame, s'inspirent aux couleurs et aux éléments présents dans la nature, évoquant l'interaction quotidienne avec notre habitat. Les surfaces des bureaux et les fiancs en aluminium multi-feuilleté, créent des jeux de formes et de volumes légers et suspendus.

Die zahlreichen Ausführungen wie Holz, Leder und Feinsteinzeug werden durch die in der Natur vorhandenen Farben und Elemente inspiriert und erinnern an die tägliche Wechselwirkung mit unserem Habitat. Die Schreibtischplatten und Außenseiten aus mehrschichtigem Aluminium schaffen Formenspiele sowie leichte und aufgehängte Volumen.

Los acabados como la madera, el cuero y el gres porcelánico, se inspiran a los colores y a los elementos presentes en la naturaleza, recordando la interacción con el medio ambiente. Los planos de trabajo y las partes laterales en aluminio multilaminar crean juegos de formas y volúmenes ligeros y en suspensión.

Многообразные отделки, такие как дерево, кожа и керамогранит, вдохновлены природными цветами и элементами, связывая образ мебельной композиции с нашей средой обитания. Столешницы письменных столов и опорные боковины из многослойного алюминия, создают игру легких и подвесных форм и объемов.



Il rivestimento coordinato del pavimento e delle pareti con lo stesso gres porcellanato degli arredi, dona una piacevole continuità visiva all'ambiente.

The matching floor and wall covering with the same unglazed porcelain as the furniture gives a pleasuring visual continuity to the environment.

Le revêtement du sol et des murs assorti avec le même grès cérame des meubles offre une agréable continuité visuelle à l'espace.

Der Fußbodenbelag und die Wandverkleidung aus dem gleichen Feinsteinzeug wie die Einrichtungen verleihen dem Raum ein angenehmes kontinuierliches Blickfeld.

El revestimiento de gres porcelánico a juego con el suelo y las paredes le da al ambiente una atractiva continuidad visual.

Покрытие пола и стен в сочетании с тем же керамогранитом, используемым для отделки мебели, дает приятный визуальный эффект единения с окружающей средой.





NATURAL LIVING





La purezza estetica ed i caldi colori delle finiture testimoniano l'anima eclettica di The Element. Lo spazio dedicato all'accoglienza diventa living, descrivendo un'atmosfera intima e familiare.

The aesthetical pureness and warm colours of the finishes testify The Element's versatile soul. The space given to the welcome becomes living, describing an intimate and familiar atmosphere.

La pureté esthétique et les couleurs chaudes des finitions, témoignent de l'âme éclectique de The Element. L'espace consacré à l'accueil devient living, créant une atmosphère intime et familiale.

Die ästhetische Reinheit und die warmen Farben der Ausführungen bezeugen den ausgewählten Wesenszug von The Element. Der dem Empfang gewidmete Platz wird zum Wohnraum, er beschreibt eine vertrauliche und familiäre Atmosphäre.

La pureza estética y los colores cálidos de los acabados dan prueba del ánimo ecléctico de The Element. El espacio dedicado al acogida se convierte en living, describiendo una atmósfera íntima y familiar.

Эстетическая чистота и теплые цвета отделки подчеркивают эклектичную душу The Element. Пространство, предназначенное для общения, становится живым и создает интимную и комфортную атмосферу.





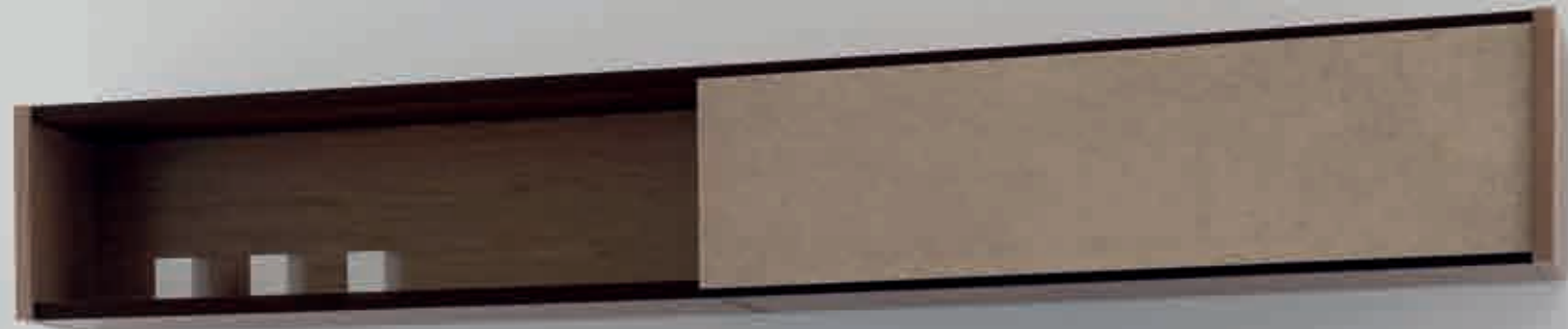









NATURAL BRAL LIGHT

Piani / Ante scorrevoli soft closing: **cuoio** - Fianchi tavolo / Struttura libreria: **essenza noce**
Worktops / Sliding "soft close" doors: **hide** - Table sides / Bookcase structure: **walnut veneer**
Surfaces / Portes coulissantes soft closing: **cuir** - Flancs table / Structure bibliothèque: **essence noyer**
Platten / Schiebetüren Soft Closing: **Leder** - Tischaußenseiten / Bücherregalkorpus: **Holzart Nussbaum**
Planos / Puertas corredizas silent system: **cuero** - Laterales mesa / Estructura librería: **nogal**
Столешницы / раздвижные створки с отделкой **из кожи** имеют механизм, снабженный доводчиком
Боковины стола / структура книжного шкафа: **из древесины ореха**







Piani tavolo: **gres porcellanato** - Ante: **vetro Stopsol**
Worktops: **unglazed porcelain** - Doors: **Stopsol glass**
Surface table: **grès cérame** - Portes: **verre Stopsol**
Tischplatten: **Feinsteinzeug** - Türen: **Stopsol-Glas**
Planos mesa: **gres porcelánico** - Puertas: **cristal Stopsol**
Столешницы стола: **из керамогранита** - створки: **стекло Stopsol**



Piani / Top / Fianchi tavolo / Ante: **essenza wengè**
Worktops / Tops / Table structure / Doors: **wengè veneer**
Surfaces / Partie supérieure / Flancs table / Portes: **essence wengè**
Platten / Abdeckplatten / Tischaußenseiten / Türen: **Holzart Wengè**
Planos / Topes / Laterales mesa / Puertas: **wengè**
Столешницы / верхние панели / Боковины стола / створки: **из древесины венге**





CONFERENCE

30°

60°

90°

45°

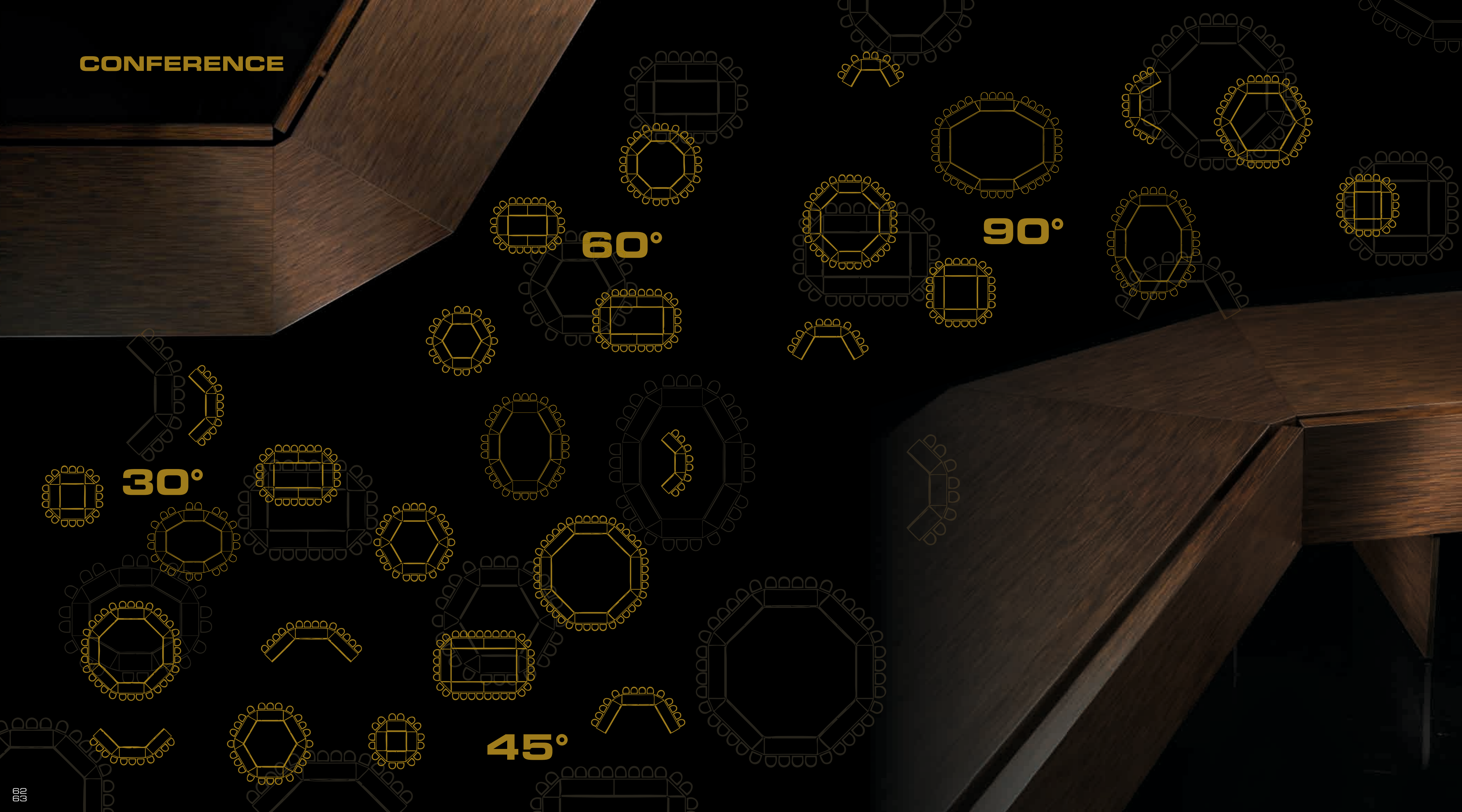

CONFERENCE

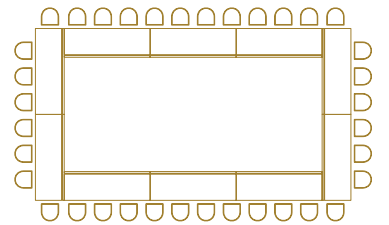
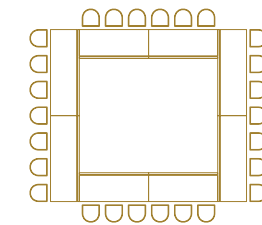
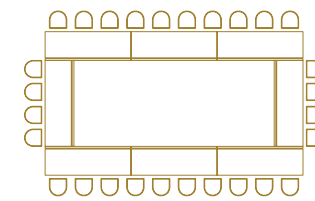
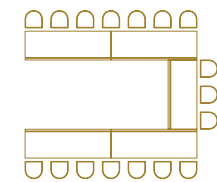
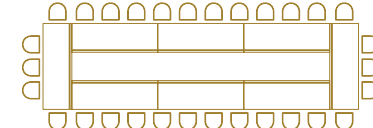
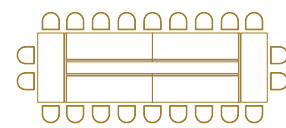



CASSETTIERE , CHEST OF DRAWERS , CAISSONS
SCHUBLADENKÄSTEN , CAJONERAS , ТУМБОЧКИ



TAVOLO COLLOQUIO , MEETING TABLE , TABLE DE CONVIVIALITÉ
BESPRECHUNGSTISCH , MESA PARA COLOGUIO , СТОЛ БРИФИНГ



MADIA , LOW STORAGE UNIT , ARMOIRE BASSE , NIEDRIGER SCHRANK , APARADOR , НИЗКИЙ ШКАФ



MOBILE DI SERVIZIO , MOBILE CREDENZA , MEUBLE DE RETOUR , BEIMÖBEL , MUEBLE DE SERVICIO , СЕРВИСНАЯ ТУМБА



PASSAGGIO CAVI , CABLE RUN , PASSAGE DE CÂBLES ,
ELEKTRISCHE VERKABELUNG , PASAJE DE CABLES , ПРОВОДКА КАБЕЛЯ



PORTA UNITA' , CPU HOLDER , SUPPORT PC , CPU TRÄGERELEMENT
PORTA CPU , ПОДСТАВКА ПОД СИСТЕМНЫЙ БЛОК

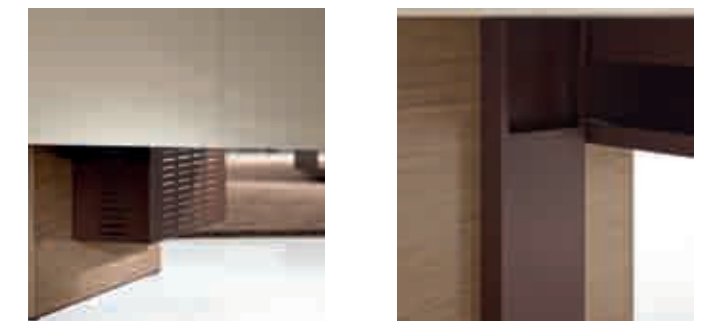

FINITURE , FINISHES , FINITIONS , AUSFÜHRUNGEN , ACABADOS , ОТДЕЛКИ

LEGNO , WOOD , BOIS EBÉNISTERIE , HOLZ , MADERA , ДЕРЕВО



Noce , Walnut , Noyer , Nussbaum
Nogel , Орех



Wengè , Wengè , Wengè , Wengè
Wengè , Венге*

CUOIO , LEATHER , CUIR , KERNLEDER , CUERO , КОЖА



*Testa di moro , Dark brown , Marron foncé
Dunkelbraun , Marrón oscuro , Sötétbarna
Темно-коричневый



Natural



Rosso , Red , Rouge , Rot , Rojo
Piros , Красный



Antracite , Anthracite , Anthracite , Anthrazit
Antracita , Антрацит

GRES PORCELLANATO , UNGLAZED PORCELAIN , GRÈS CÉRAME , PORZELLANFEINSTEINZEUG , UNGLASIERT , GRES PORCELÁNICO , КЕРАМОГРАНИТ



K 101



K 102



K 103

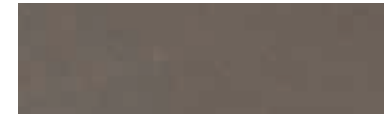

K 104



K 105



K 106

ANTE IN VETRO , GLASS DOORS , PORTES VERRE , GLASTÜREN
PUERTAS DE CRISTAL , СТЕКЛЯННЫЕ СТВОРКИ



Stopsol



Corten

STRUTTURE CONTENITORI , CREDENZA STRUCTURE ,
STRUCTURES CONTENEURS , ANRICHE-STRUKTUREN
ESTRUCTURA CONTENEDORES , СТРУКТУРЫ КОНТЕЙНЕРОВ



Sabbia , Sand , Sable , Sand
Arena , Песочный



Argento , Silver grey , Argenté
Silber , Plata , Серебристый



Antracite , Anthracite , Anthracite
Anthrazit , Antracita , Антрацит

DIVANI PELLE , LEATHER SOFAS , CANAPÉS EN CUIR , LEDERSOFAS , SOFÁS DE PIEL , КОЖАНЫЕ ДИВАНЫ



P801



P802



P803



P804



P805



P806



P807



P808



P809

*Finitura passamano , Inlay finish , Finition sous-main , Auflage Ausführung , Acabado vade , Отделка бюара

	LEGNO WOOD BOIS HOLZ MADERA ДЕРЕВО	CUOIO LEATHER CUIR KERNLEDER CUERO КОЖА	GRES PORCELLANATO UNGLAZED PORCELAIN GRÈS CÉRAME PORZELAN UNGLASIERT GRES PORCELÁNICO КЕРАМОГРАНИТ	CORTEN	PELLE LEATHER CUIR KERNLEDER PIEL КОЖА	STOPSOL
	■	■	■	—	—	—
	■	■	—	—	—	—
	■	■	■	—	—	—
	■	—	—	—	—	—
	■	■	—	—	—	—
	—	—	—	■	—	—
	—	—	—	—	■	—
	—	—	—	■	—	—
	■	—	—	—	—	—
	—	—	—	—	—	■

SPECIFICHE TECNICHE , TECHNICAL DETAILS , SPÉCIFICATIONS TECHNIQUES , TECHNISCHE SPEZIFIKATIONEN , CARACTERÍSTICAS TÉCNICAS , ТЕХНИЧЕСКИЕ ХАРАКТЕРИСТИКИ

SCRIVANIE , DESKS , BUREAUX , SCHREIBTISCHE , ESCRITORIOS , ПИСЬМЕННЫЕ СТОЛЫ

cm. 220 / 240 / 298 L 100 P 76 H
in. 86,6 / 94,5 / 117,3 W 39,4 D 29,9 H

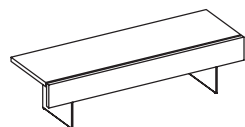

ATE-10009
ATE-10010
ATE-10047

ALLUNGO , EXTENSION , RETOUR , TISCH VERLÄNGERUNGEN , PROLONGACIÓN , ПРИСТАВКА

cm. 120 L 70 P 76 H
in. 47,2 W 27,6 D 29,9 H

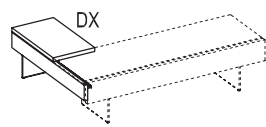

ATE-50301

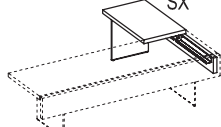

ATE-50302

SCRIVANIE PER MOBILE SERVIZIO , DESKS FOR MOBILE CREDENZA , BUREAUX POUR MEUBLE DE RETOUR , SCHREIBTISCHE FÜR BEIMÖBEL , ESCRITORIOS PARA MUEBLE DE SERVICIO , ПИСЬМЕННЫЕ СТОЛЫ ДЛЯ СЕРВИСНОЙ ТУМБЫ

cm. 240 / 298 L 100 P 76 H
in. 94,5 / 117,3 W 39,4 D 29,9 H

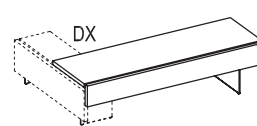

ATE-13710
ATE-13747

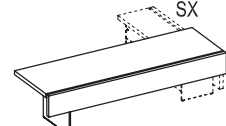

ATE-13810
ATE-13847

MOBILE SERVIZIO , MOBILE CREDENZA , MEUBLE DE RETOUR , BEIMÖBEL , MUEBLE DE SERVICIO , СЕРВИСНАЯ ТУМБА

cm. 203 L 60 P 64 H
in. 79,9 W 23,6 D 25,2 H

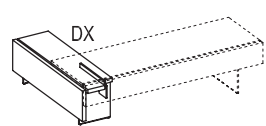

ATE-60048

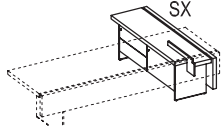

ATE-60148

CONTENTORI , CABINETS , CONTENEURS , CONTAINER , RECIPIENTES , КОНТЕЙНЕРЫ

cm. 50 L 59 P 57 H
in. 19,7 W 23,2 D 22,4 H



TE-1101056

cm. 203 L 60 P 64 H
in. 79,9 W 23,6 D 25,2 H

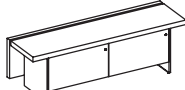

ATE-92703

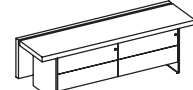

ATE-92735

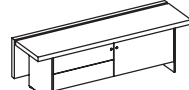

ATE-92736

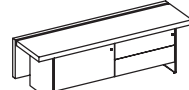

ATE-92737

cm. 240 L 60 P 93 H
in. 94,5 W 23,6 D 36,6 H

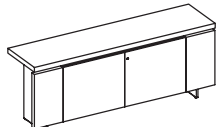

ATE-92838

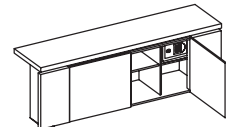

ATE-92840

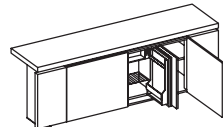

ATE-92839

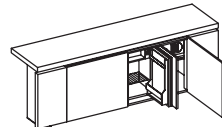

ATE-92841

LIBRERIA , BOOKSHELF , BIBLIOTHÈQUE , BÜCHERSCHRANK , KISSZEKRENYEK , LIBRERÍA , КНИЖНЫЙ ШКАФ

cm. 300 L 45 P 179 H
in. 118,1 W 17,7 D 70,5 H

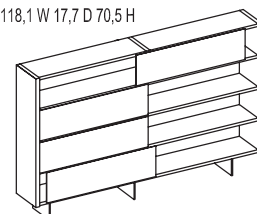

ATE-92907

PENSILE , OVERHANGING CABINET , ARMOIRE SUSPENDUE , HÄNGE RECIPIENTE COLGANTE , ПОДВЕСНОЙ ШКАФ

cm. 300 L 45 P 44 H
in. 118,1 W 17,7 D 17,3 H

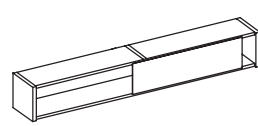

ATE-93007

COMPLEMENTI , ACCESSORIES , COMPLÉMENTS , ZUBEHÖR , ACCESORIOS , АКЦЕССУАРЫ

cm. 100 L 50 P
in. 39,4 W 19,7 D

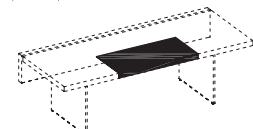

TE-3706100

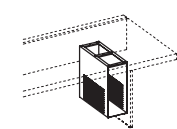

TE-3701053

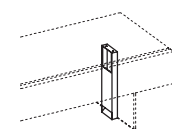

TE-1003069

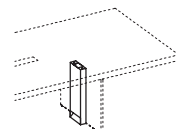

TE-1004057

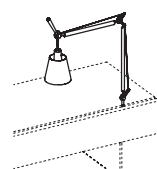

ATE-99002

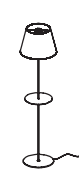

C4-4107

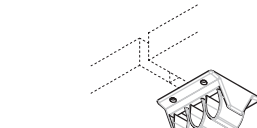

C4-3966014

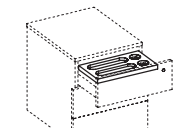

C4-4207038

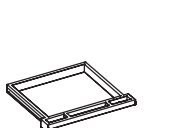

C4-4207038

DIVANI , SOFAS , CANAPÉS , SOFAS , SOFÁS , ДИВАНЫ

cm. 125 L 90 P 70 H
in. 49,2 W 35,4 D 27,6 H

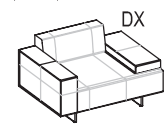

A4C-98092

cm. 125 L 90 P 70 H
in. 49,2 W 35,4 D 27,6 H

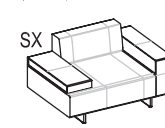

A4C-98093

cm. 200 L 90 P 70 H
in. 78,7 W 35,4 D 27,6 H

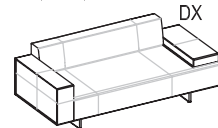

A4C-98192

cm. 200 L 90 P 70 H
in. 78,7 W 35,4 D 27,6 H

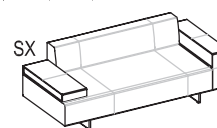

A4C-98193

cm. 260 L 90 P 70 H
in. 102,4 W 35,4 D 27,6 H

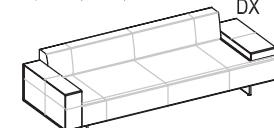

A4C-98292

cm. 260 L 90 P 70 H
in. 102,4 W 35,4 D 27,6 H

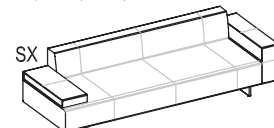

A4C-98293

TAVOLINI , COFFEE TABLES , TABLES BASSES , NIEDRIGER TISCH , MESITAS DE CAFÉ , СТОЛИКИ

cm. 203 L 120 P 30 H
in. 79,9 W 47,2 D 11,8 H

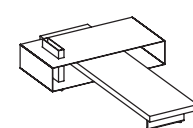

ATE-30056

cm. 120 L 60 P 30 H
in. 47,2 W 23,6 D 11,8 H

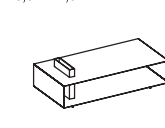

TE-3603120

cm. 203 L 51 P 21 H
in. 79,9 W 20,1 D 8,3 H

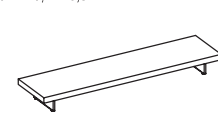

ATE-30048

cm. 120 L 70 P 30 H
in. 47,2 W 27,6 D 11,8 H

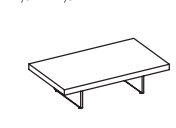

ATE-30003

cm. 100 L 100 P 30 H
in. 39,4 W 39,4 D 11,8 H

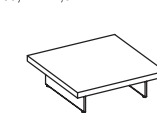

ATE-30002

cm. 40 L 40 P 40 H
in. 15,7 W 15,7 D 15,7 H



TE-3602040

TAVOLI RIUNIONE , MEETING TABLES , TABLES DE RÉUNION , KONFERENZTISCH , MESAS DE REUNIÓN , ПЕРЕГОВОРНЫЕ СТОЛЫ

cm. 150 L 75 P 76 H
in. 59,1 W 29,5 D 29,9 H

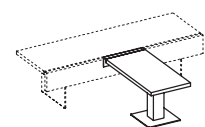

ATE-31055

cm. 100 L 100 P 76 H
in. 39,4 W 39,4 D 29,9 H

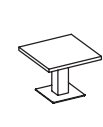

ATE-30102

cm. 240 / 298 L 120 P 76 H
in. 94,5 / 117,3 W 47,2 D 29,9 H

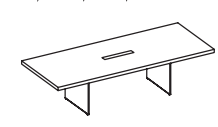

ATE-30210
ATE-30247

cm. 309 L 150 P 76 H
in. 121,7 W 59,1 D 29,9 H

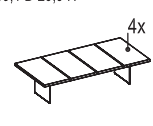

ATE-30225

cm. 387 L 150 P 76 H
in. 152,4 W 59,1 D 29,9 H

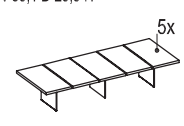

ATE-30249

cm. 465 L 150 P 76 H
in. 183,1 W 59,1 D 29,9 H

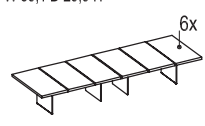

ATE-30250

cm. 543 L 150 P 76 H
in. 213,8 W 59,1 D 29,9 H

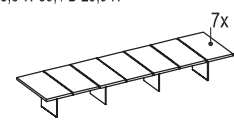

ATE-30222

cm. 621 L 150 P 76 H
in. 244,5 W 59,1 D 29,9 H

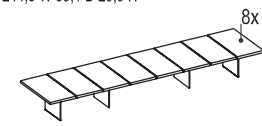

ATE-30224

cm. 699 L 150 P 76 H
in. 275,2 W 59,1 D 29,9 H

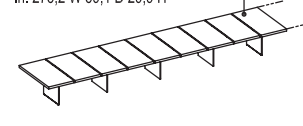

ATE-30253

ESEMPI , EXAMPLES , EXEMPLES , BEISPIEL , EJEMPLOS , ПРИМЕРЫ

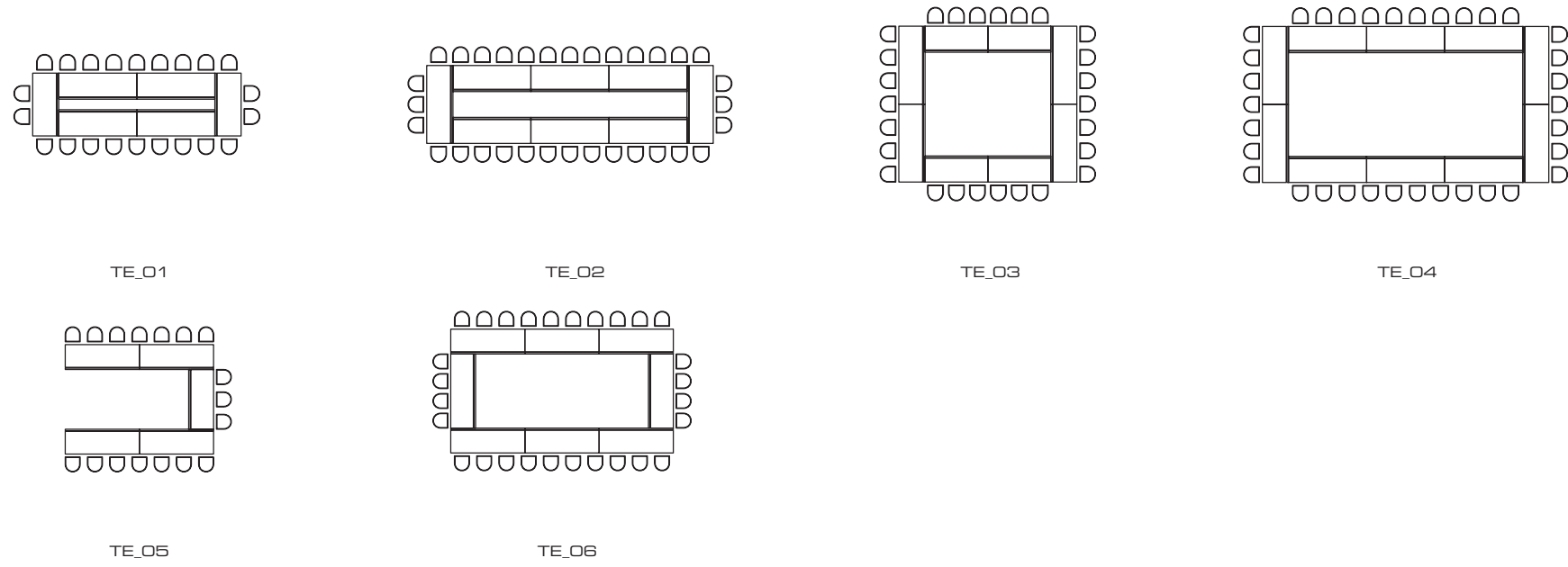

RACCORDI SCRIVANIE , CONNECTING TOPS , PLATEAUX DE RACCORD , VERBINDUNGSPLATTEN , PLANOS DE UNIÓN
СОЕДИНИТЕЛЬНЫЕ СТОЛШНИЦЫ

30°	cm 92 L, 51 P. in 36,2 W, 20,1 D.	45°	cm 94 L, 72 P. in 37 W, 28,3 D.	60°	cm 98 L, 97 P. in 37,8 W, 34,2 D.	90°	cm 101 L, 101 P. in 39,8 W, 39,8 D.
TE_3163030		TE_3149045		TE_3164060		TE_3107090	

ESEMPI , EXAMPLES , EXEMPLES , BEISPIEL , EJEMPLOS , ПРИМЕРЫ

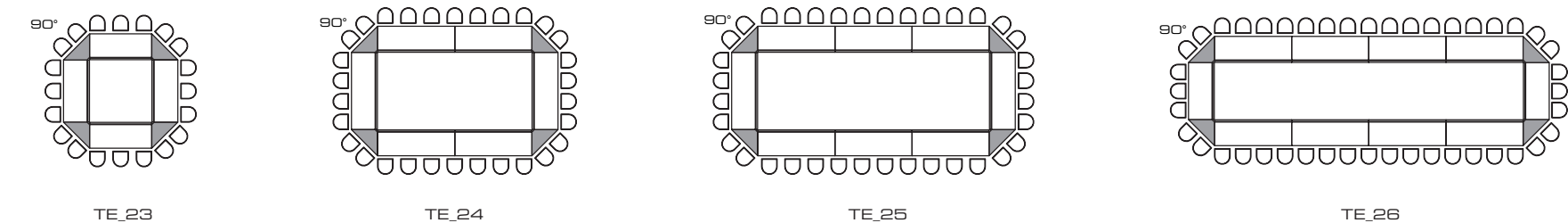
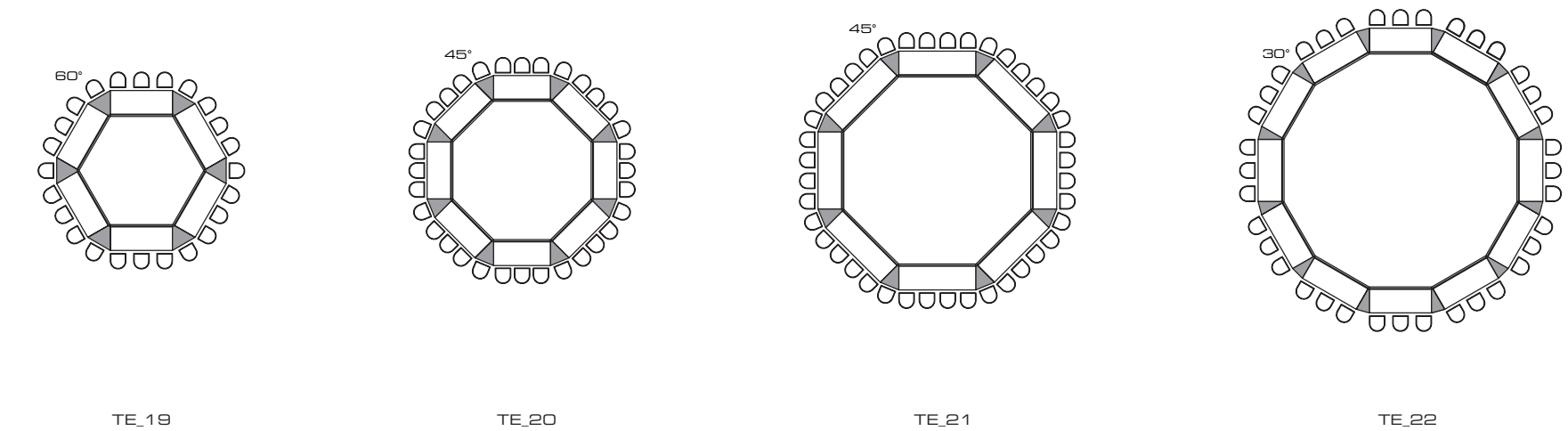
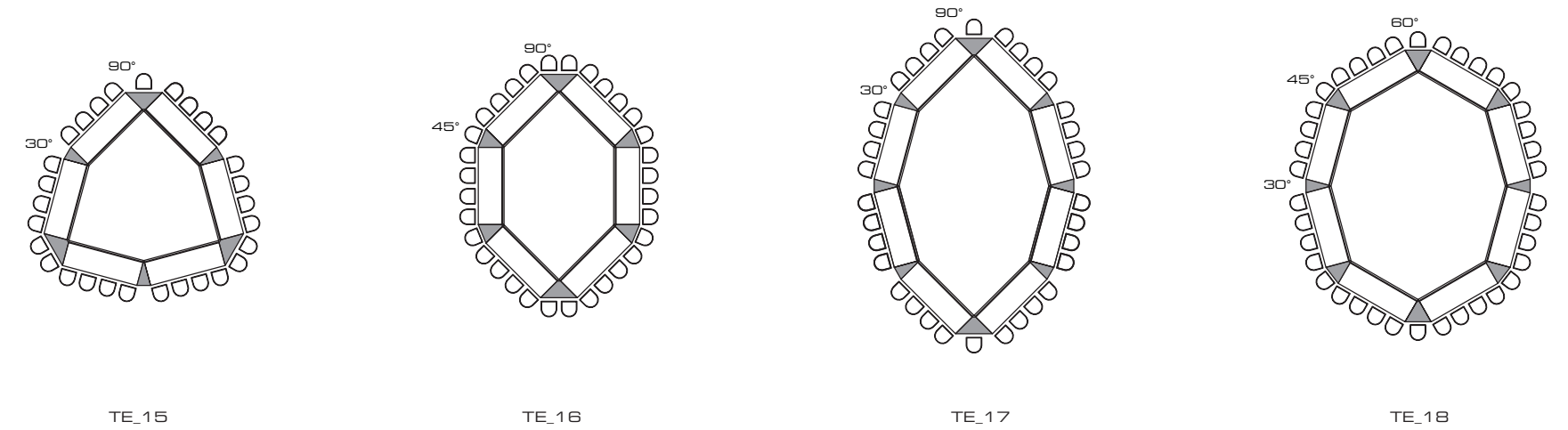
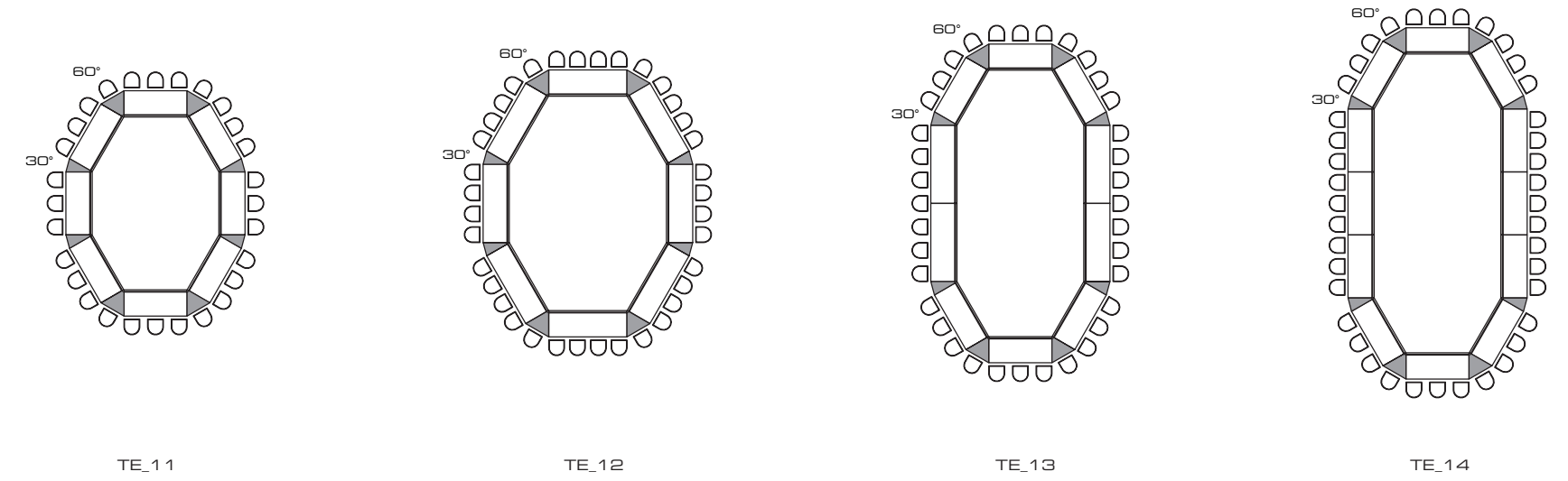
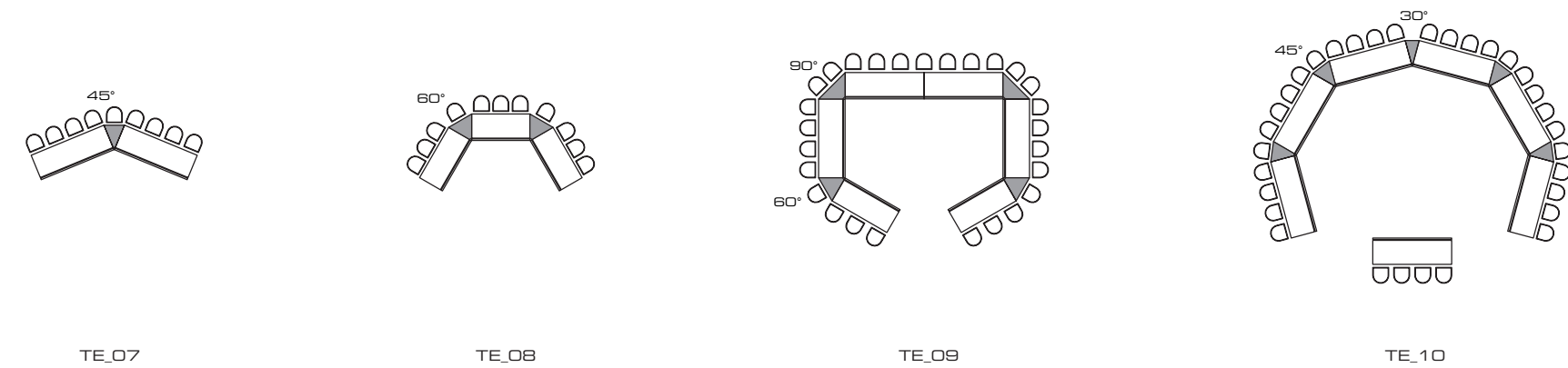

ARMADI H.82 , H.82 CM STORAGE UNITS , ARMOIRES H.82 , SCHRÄNKE H.82 , ARMARIOS H.82 , ШКАФЫ H.82

cm. 45 L 45 P 82 H
in. 17,7 W 17,7 D 32,3 H

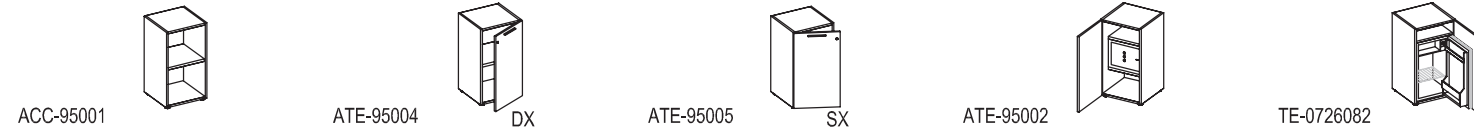

cm. 90 L 45 P 82 H
in. 35,4 W 17,7 D 32,3 H

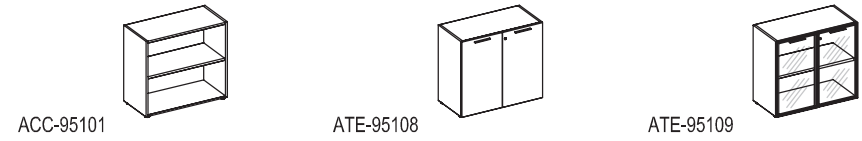

ARMADI H.122 , H.122 CM STORAGE UNITS , ARMOIRES H.122 , SCHRÄNKE H.122 , ARMARIOS H.122 , ШКАФЫ H.122

cm. 45 L 45 P 122 H
in. 17,7 W 17,7 D 48,0 H

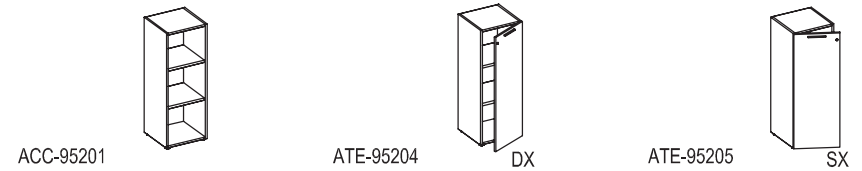

cm. 90 L 45 P 122 H
in. 35,4 W 17,7 D 48,0 H

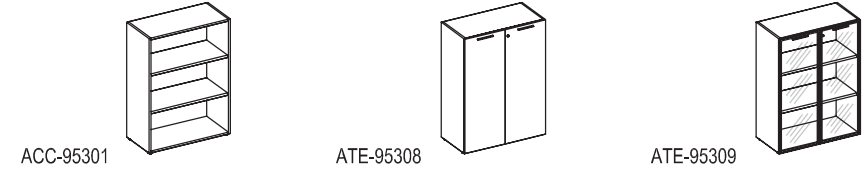

ARMADI H.162 , H.162 CM STORAGE UNITS , ARMOIRES H.162 , SCHRÄNKE H.162 , ARMARIOS H.162 , ШКАФЫ H.162

cm. 45 L 45 P 162 H
in. 17,7 W 17,7 D 63,8 H

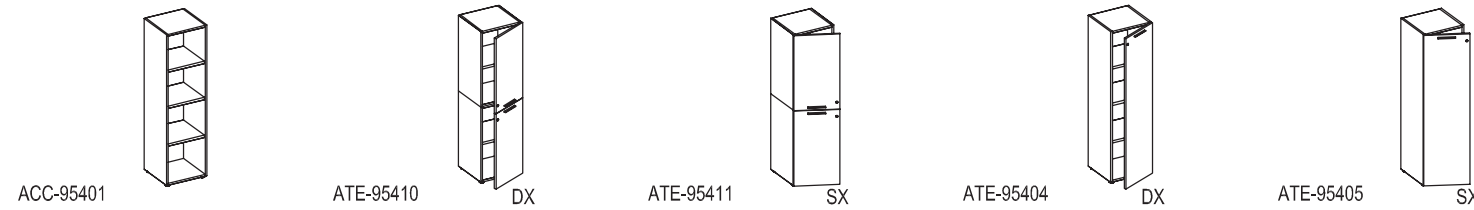

cm. 90 L 45 P 162 H
in. 35,4 W 17,7 D 63,8 H

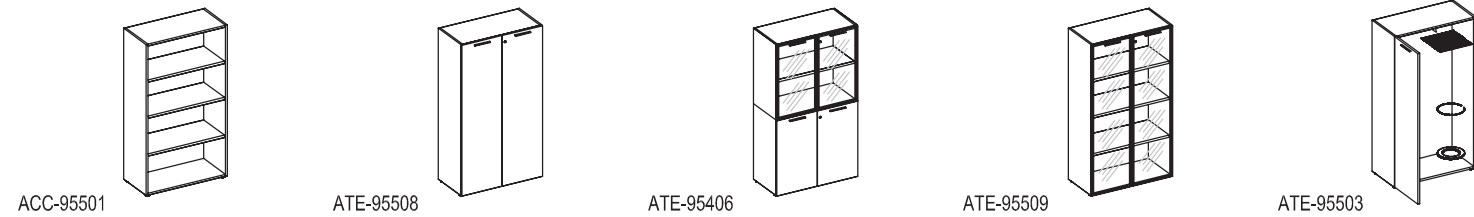

ARMADI H.202 , H.202 CM STORAGE UNITS , ARMOIRES H.202 , SCHRÄNKE H.202 , ARMARIOS H.202 , ШКАФЫ H.202

cm. 45 L 45 P 202 H
in. 17,7 W 17,7 D 79,5 H

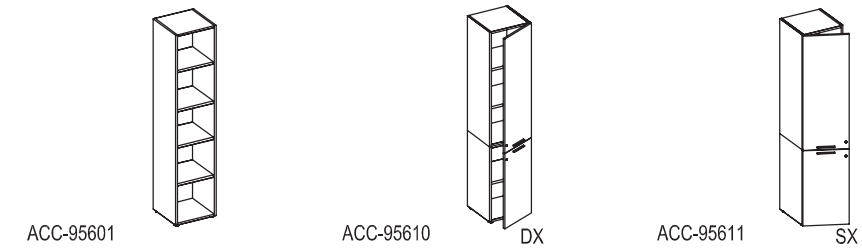

cm. 90 L 45 P 202 H
in. 35,4 W 17,7 D 79,5 H

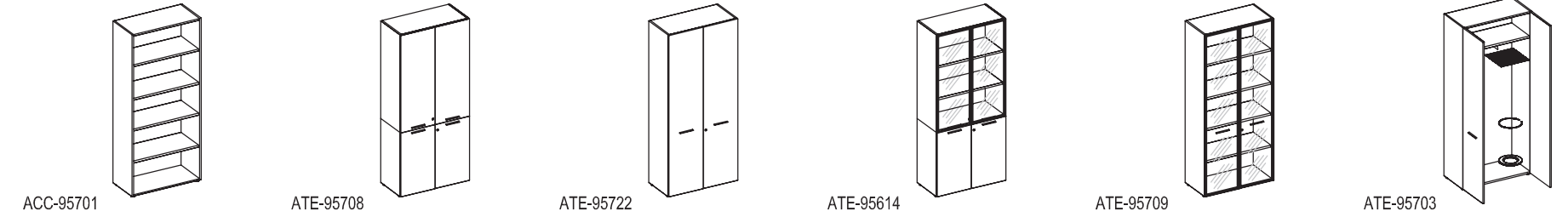

COMPLEMENTI ARMADI , STORAGE UNITS ACCESORIES , COMPLÉMENTS POUR ARMOIRES , ZUBEHÖR FÜR SCHRÄNKE
ACCESORIOS DE ARMARIOS , ДОПОЛНЕНИЯ ДЛЯ ШКАФОВ

cm. 45 L 45 P 2 H
in. 17,7 W 17,7 D 0,8 H

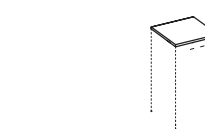

MP-1212045

cm. 90 L 45 P 2 H
in. 35,4 W 17,7 D 0,8 H

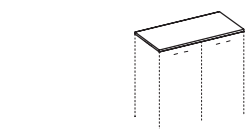

MP-1212090

cm. 135 L 45 P 2 H
in. 53,2 W 17,7 D 0,8 H

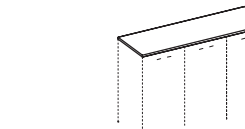

MP-1212135

cm. 180 L 45 P 2 H
in. 70,8 W 17,7 D 0,8 H

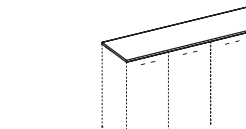

MP-1212180

cm. 225 L 45 P 2 H
in. 88,6 W 17,7 D 0,8 H

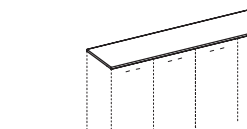

MP-1212225

cm. 270 L 45 P 2 H
in. 106,3 W 17,7 D 0,8 H

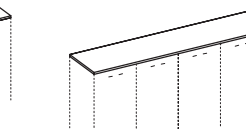

MP-1212270

cm. 84 L 46 P 4 H
in. 33,1 W 18,1 D 1,6 H

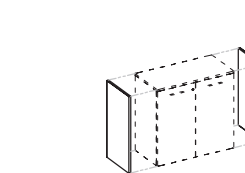

MP-1512082

cm. 124 L 46 P 4 H
in. 48,8 W 18,1 D 1,6 H

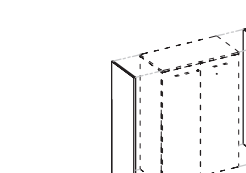

MP-1512122

cm. 164 L 46 P 4 H
in. 64,6 W 18,1 D 1,6 H

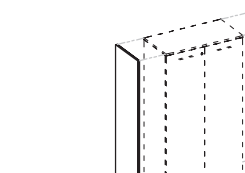

MP-1512162

cm. 204 L 46 P 4 H
in. 80,3 W 18,1 D 1,6 H

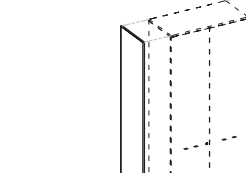

MP-1512202

cm. 51 L 51 P 5 H
in. 20,1 W 20,1 D 2,0 H

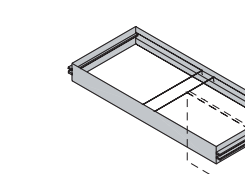

C4-3715086

cm. 86 L 38 P 9 H
in. 33,9 W 15,0 D 3,5 H

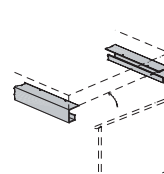

C4-3962086

cm. 86 L 40 P 2 H
in. 33,9 W 15,7 D 0,8 H



C4-3962086



Il sistema Qualità Uffix è certificato secondo la norma ISO 9001 .
I prodotti Uffix sono testati presso il laboratorio prove CATAS .
I prodotti Uffix sono testati secondo le normative UNI .
I prodotti Uffix sono conformi al D.L. 81/08

Uffix's quality system is certified according to the ISO 9001 norm.
Uffix products are tested in the CATAS tests laboratory.
Uffix products are tested according to UNI norms.
Uffix products are in conformity with the law D.L. 81/08 .

CATAS

Le système qualité Uffix est certifié selon la normative ISO 9001 .
Les produits Uffix sont testés chez le laboratoire des essais CATAS .
Les produits Uffix sont testés selon les normes UNI .
Les produits Uffix sont conformes à la loi D.L. 81/08

UNI

Das Qualitätssystem Uffix ist nach den Standards ISO 9001 zertifiziert.
Uffix Produkte werden vom technischen Prüf-Labor „CATAS“ kontrolliert.
Die Qualität der Uffix Produkte wird nach UNI Standards kontrolliert.
Uffix Produkte entsprechen den Vorschriften D.L. 81/08

81/08

El sistema Qualità Uffix está certificado según la normativa ISO 9001 .
Los productos Uffix están testados por el laboratorio de pruebas CATAS .
Los productos Uffix están testados según las normativas UNI .
Los productos Uffix son conformes al D.L. 81/08

Система Качества Компании Уффик сертифицирована по стандарту ISO 9001.
Продукция Компании Уффик тестируется в испытательной лаборатории CATAS.
Продукция Компании Уффик тестируется в соответствии со стандартом UNI.
Продукция Компании Уффик соответствует D.L. 81/08



© Uffix S.r.l. - Edizione Settembre 2014

Tutti i diritti riservati: Uffix si riserva di apportare le modifiche ritenute necessarie senza obbligo di preavviso. Immagini e rese cromatiche sono soggette alle rese di stampa. Dati e misure non sono vincolanti. Vietata la riproduzione anche parziale. I marchi citati nel presente catalogo sono di proprietà delle rispettive società.

© Uffix S.r.l. - September 2014 Edition

All rights reserved: Uffix is entitled to do the necessary modifications without any notice. Images and colour rendering may change according to the printer used. Data and dimensions are not binding. The reproduction, even if partial, is forbidden. The brands listed in the present catalogue belong to the respective companies.

© Uffix S.r.l. - Edition Septembre 2014

Tous droits réservés: Uffix se réserve le droit d'apporter les modifications nécessaires sans obligation d'en aviser sa clientèle. Les images et rendus chromatiques sont sujets aux rendus d'impression. Les descriptions et mesures ne sont pas contractuelles. Reproduction totale ou partielle interdite. Les marques citées dans ce catalogue appartiennent aux respectives sociétés.

© Uffix S.r.l. - September Ausgabe 2014

Alle Rechte vorbehalten: Uffix verpflichtet sich, über notwendige Änderungen zu informieren. Bilder sowie farbliche Abweichungen sind druckbedingt möglich. Daten und Masse sind nicht verbindlich. Jede Vervielfältigung bzw. Reproduktion ist verboten. Die Markenzeichen, die auf diesen Katalog genannt sind, gehören der jeweiligen Gesellschaften.

© Uffix S.r.l. - Edición Septiembre 2014

Todos los derechos reservados: Uffix se reserva el derecho de efectuar las modificaciones necesarias sin previo aviso. Imágenes y efectos cromáticos dependen de la calidad de la impresora. Datos y medidas no son vinculantes. No se admite la reproducción ni parcial. Las marcas indicadas en el presente catálogo son de propiedad de las respectivas sociedades.

© Уффик С.Р.Л. - Сентябрь 2014

Защищенные права: Уффик оставляет за собой право вносить, по своему усмотрению, в случае необходимости, изменения без предварительного уведомления. Фотографии и их цветовая гамма – в соответствии с характеристиками печати. Характеристики и размеры могут быть изменены. Копирование, в том числе и частичное, запрещено. Упомянутые торговые марки в настоящем каталоге являются собственностью данной фирмы.

Product Design _ DriussoAssociati | Architects

Product Engineering _ CRS Uffix

Art Direction _ DriussoAssociati | Architects

Graphic Design _ DriussoAssociati | Architects

Photo _ Andrea Pancino

Color Separation _ Selekta

Print _ Grafiche Antiga

uffix[®]

Uffix S.r.l.
Via Pontal 13
33087 Pasiano (PN)
ITALY
Tel. +39.0434.625291
Fax +39.0434.625979
info@uffix.com
www.uffix.com

uffix[®]